

Mag-FLEX Probe

Installation Manual

Notice

Veeder-Root makes no warranty of any kind with regard to this publication, including, but not limited to, the implied warranties of merchantability and fitness for a particular purpose.

Veeder-Root shall not be liable for errors contained herein or for incidental or consequential damages in connection with the furnishing, performance, or use of this publication.

Veeder-Root reserves the right to change system options or features, or the information contained in this publication.

This publication contains proprietary information which is protected by copyright. All rights reserved. No part of this publication may be photocopied, reproduced, or translated to another language without the prior written consent of Veeder-Root.

Contact TLS Systems Technical Support for additional troubleshooting information at 800-323-1799.

DAMAGE CLAIMS / LOST EQUIPMENT

Thoroughly examine all components and units as soon as they are received. If any cartons are damaged or missing, write a complete and detailed description of the damage or shortage on the face of the freight bill. The carrier's agent must verify the inspection and sign the description. Refuse only the damaged product, not the entire shipment.

Veeder-Root must be notified of any damages and/or shortages within 30 days of receipt of the shipment, as stated in our Terms and Conditions.

VEEDER-ROOT'S PREFERRED CARRIER

1. Contact Veeder-Root Customer Service at 800-873-3313 with the specific part numbers and quantities that were missing or received damaged.
2. Fax signed Bill of Lading (BOL) to Veeder-Root Customer Service at 800-234-5350.
3. Veeder-Root will file the claim with the carrier and replace the damaged/missing product at no charge to the customer. Customer Service will work with production facility to have the replacement product shipped as soon as possible.

CUSTOMER'S PREFERRED CARRIER

1. It is the customer's responsibility to file a claim with their carrier.
2. Customer may submit a replacement purchase order. Customer is responsible for all charges and freight associated with replacement order. Customer Service will work with production facility to have the replacement product shipped as soon as possible.
3. If "lost" equipment is delivered at a later date and is not needed, Veeder-Root will allow a Return to Stock without a restocking fee.
4. Veeder-Root will NOT be responsible for any compensation when a customer chooses their own carrier.

RETURN SHIPPING

For the parts return procedure, please follow the appropriate instructions in the "General Returned Goods Policy" pages in the "Policies and Literature" section of the Veeder-Root **North American Environmental Products** price list. Veeder-Root will not accept any return product without a Return Goods Authorization (RGA) number clearly printed on the outside of the package.

FCC INFORMATION

This equipment complies with the requirements in Part 15 of the FCC rules for a Class A computing device. Operation of this equipment in a residential area may cause unacceptable interference to radio and TV reception requiring the operator to take whatever steps are necessary to correct the interference.

Warranty

TLS-350R, TLS-350 PLUS, TLS-350J AND TLS-300I/C MONITORING SYSTEMS

We warrant that this product shall be free from defects in material and workmanship for a period of one (1) year from the date of installation or twenty-four (24) months from the date of invoice, whichever occurs first. During the warranty period, we or our representative will repair or replace the product, if determined by us to be defective, at the location where the product is in use and at no charge to the purchaser. LAMPS, FUSES, AND LITHIUM BATTERIES ARE NOT COVERED UNDER THIS WARRANTY.

We shall not be responsible for any expenses incurred by the user.

This warranty applies only when the product is installed in accordance with Veeder-Root's specifications, and a Warranty Registration and Checkout Form has been filed with Veeder-Root by an authorized Veeder-Root Distributor. This warranty will not apply to any product which has been subjected to misuse, negligence, accidents, systems that are misapplied or are not installed per Veeder-Root specifications, modified or repaired by unauthorized persons, or damage related to acts of God.

If "Warranty" is purchased as part of the Fuel Management Service, Veeder-Root will maintain the equipment for the life of the contract in accordance with the written warranty provided with the equipment. A Veeder-Root Fuel Management Services Contractor shall have free site access during Customer's regular working hours to work on the equipment. Veeder-Root has no obligation to monitor federal, state or local laws, or modify the equipment based on developments or changes in such laws.

MODULES, KITS, OTHER COMPONENTS (PARTS PURCHASED SEPARATE OF A COMPLETE CONSOLE)

We warrant that this product, exclusive of lithium batteries, shall be free from defects in material and workmanship for a period of fifteen (15) months from date of invoice. We warrant that the lithium batteries shall be free from defects in material and workmanship for a period of 90 days from date of invoice. We will repair or replace the product if the product is returned to us; transportation prepaid, within the warranty period, and is determined by us to be defective. This warranty will not apply to any product which has been subjected to misuse, negligence, accidents, systems that are misapplied or are not installed per Veeder-Root specifications, modified or repaired by unauthorized persons, or damage related to acts of God.

We shall not be responsible for any expenses incurred by the user.

MAG-FLEX PROBE

The same warranty policies for the MAG Plus Rigid Probe apply to the Mag-FLEX Probe. When the Probe is purchased with a monitoring system (console), the warranty period is one (1) year from the date of installation or twenty-four (24) months from the invoice date, whichever occurs first. Parts and labor are covered in this warranty. When the Probe is purchased individually, it has a 15-month parts only warranty from the invoice date. Please refer to the Policies and Literature section in the Price Book.

Veeder-Root will not warranty the probe if its damage is caused by failing to follow the Veeder-Root MAG-FLEX Installation & Setup Manual (577014-042). Each Mag-FLEX Probe is made to order, and therefore cannot be returned for credit.

Introduction	
Tank Gauge Requirements	1
Wireless System Requirements	1
Contractor Certification Requirements	1
Related Documents	2
Product Marking Information	2
Related Documents	2
Safety Warnings	3
Safety Symbols	4
GENERAL PRECAUTIONS	4
SPECIAL TOOLS REQUIRED For Transmitter Installation	5
General AST Guidelines	5
AST Construction Safe Work Practices	5
Personal Protective Equipment	6
Before you Begin	6
Wireless Installations	6
Hard-Wired Installations	6
Mag-FLEX Probe Overview	
Product Description	7
Mag-FLEX Probe Limitations	7
Mag-FLEX Technical Data	8
Mag-FLEX Probes Part Number Specification	8
Mag-FLEX Spare Parts And Accessories	9
National Electrical Code Compliance	9
Mag-FLEX Probe Wire Length	9
Veeder-Root Parts	9
Example Drawings	
Example Mag-FLEX Probe Site Layout Drawing - Wireless Installation	10
Example Mag-FLEX Probe Site Layout Drawing - Hard-Wired Installation	11
Mag-FLEX Probe Length Calculation	12
Probe Handling	13
System Safety Layout	
Field Cable Ducting / Cable Trays	14
Cable Specifications For Intrinsically Safe Apparatus Cabling	14
Mag-FLEX Installation & Handling Procedures	
Probe Installation Requirements	15
Miscellaneous Requirements	15
Tank Entry	15
Probe Assembly	15
Tools And Materials	15
Mag-FLEX Probe Installation	16
Mag-FLEX Probe Field Wiring Connections	21
Optional Junction Box - Wired Installations Only	21
Veeder-Root Encapsulation Kits	22
TLS setup	25

Figures

Figure 1.	Site Drawing - Example TLS RF Wireless 2 System Site Layout – Two Mag-FLEX Probes	10
Figure 2.	Site Drawing - Example Hardwired System Site Layout – Two Mag-FLEX Probes	11
Figure 3.	Mag-FLEX Probe Parameters	12
Figure 4.	Junction Box Installation Examples.....	20
Figure 5.	Veeder-Root Single- And Dual-Channel Encapsulation Kit Installation Examples	20
Figure 6.	Splice Length Dimensions	22
Figure 7.	Splice Connections	23
Figure 8.	Removing Sealing Compound Clip	24
Figure 9.	Pouring Sealing Compound Into Sleeve	24

Tables

Table 1.	Dimensions For Mag-FLEX Probe Tank Opening	7
Table 2.	Part Number Nomenclature	9

Introduction

This manual contains installation instructions for the Veeder-Root Mag-FLEX probe. Procedures contained within this manual include:

- Site layout considerations
- Installing the Mag-FLEX
- Cabling between the Mag-FLEX and the TLS Console
- Connecting the Mag-FLEX probe cable and battery pack cable to the transmitter
- TLS Console used with the Mag-FLEX.

Tank Gauge Requirements

The Mag-FLEX is a digital flexible probe able to read temperature, product level and water level in tanks up to 15.0 meters. The Mag-FLEX enables liquid height, water height and temperature to be measured within fuel storage vessels with maximum liquid levels up to 9.9 metres with TLS2 and 15.0 metres with TLS-3XX and TLS-450. For storage vessels with maximum liquid levels up to 3.66 metres it is recommended that a Veeder-Root Mag Plus magnetostrictive probe is used.

Console with Mag-FLEX	Max Height (feet)	Max Volume (gallons)
TLS2	32.5	260,000
TLS-300	49.2	999,999
TLS-350	49.2	999,999
TLS-450	49.2	2,641,720
TLS4	49.2	2,641,720

Wireless System Requirements

The Veeder-Root Wireless 2 (W2) System replacement/spare parts are listed below:

- 330020-668 TLS RF Console for Wireless 2
- 330020-674 Transmitter for Wireless 2 devices
- 330020-669 Receiver for Wireless 2
- 330020-670 Repeater for Wireless 2

Contractor Certification Requirements

Veeder-Root requires the following minimum training certifications for contractors who will install and setup the equipment discussed in this manual:

Installer (Level 1) Certification: Contractors holding valid Installer Certification are approved to perform wiring and conduit routing; equipment mounting; probe, sensor and carbon canister vapor polisher installation; wireless equipment installation; tank and line preparation; and line leak detector installation.

ATG Technician (Level 2/3 or 4) Certification: Contractors holding valid ATG Technician Certifications are approved to perform installation checkout, startup, programming and operations training, system tests,

troubleshooting and servicing for all Veeder-Root Series Tank Monitoring Systems, including Line Leak Detection. In addition, Contractors with the following sub-certification designations are approved to perform installation checkout, startup, programming, system tests, troubleshooting, service techniques and operations training on the designated system.

- Wireless 2
- Tall Tank

Warranty Registrations may only be submitted by selected Distributors.

Related Documents

It is important that installers have knowledge of all relevant procedures before commencing work. Read and understand all manuals thoroughly. Do not undertake work without understanding safety and required installation practices. For ATG installation and set-up refer to the appropriate TLS manual.

577013-964 TLS RF Wireless 2 System (W2) Installation and Maintenance Guide

577013-756 TLS2 Site Prep Manual

576013-879 TLS-3XX Site prep and Installation Manual

577013-879 TLS-450 Site Prep and Installation Manual

577014-022 8601 Series Console/TLS4 Site Prep Certification Manual

577014-056 Mag-FLEX Probe Low Level Water Float Kit Installation Guide

Product Marking Information

RELATED DOCUMENTS

Documents Required to Install Equipment

This intrinsically safe apparatus is only for use as part of a Veeder-Root Automatic Tank Gauging System (ATG Console with probes and sensors). To install intrinsically safe apparatus, use the specific control drawing that appears on the nameplate of the applicable associated apparatus (ATG Console):

Equipment	UL/cUL Control Drawing Document No.
Associated Apparatus	
TLS-450/8600	331940-008
TLS-350, TLS-350R	331940-011
TLS-300	331940-013
TLS-50 or TLS2 or TLS-IB	331940-014
TLS4/8601	331940-018
Intrinsically Safe Apparatus for Wireless Applications	
Tank Gauge Accessories	331940-012

The control drawings contain information related to the correct installation of the overall intrinsically Safe System. This includes information such as maximum number of apparatus, specific apparatus allowed in the system, maximum cable lengths, references to codes, proper grounding and so on. Control drawings can be found on the

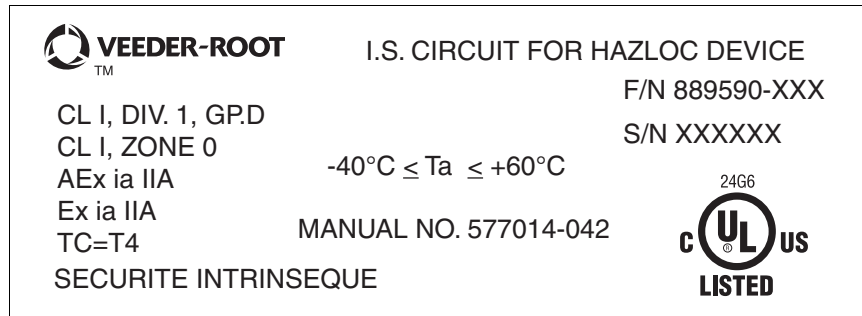

accompanying Compact Disk (TECH DOCS CD) or on the internet at veeder.com under SUPPORT; VR TECHNICAL DOCUMENTS; DRAWINGS.

Product Label Contents



Safety Warnings









To protect yourself and your equipment, observe the following warnings and important information:

 WARNING	
	<p>This product is to be installed in systems operating near locations where highly combustible fuels or vapors may be present.</p> <p>FAILURE TO COMPLY WITH THE FOLLOWING WARNINGS AND SAFETY PRECAUTIONS COULD CAUSE DAMAGE TO PROPERTY, ENVIRONMENT, RESULTING IN SERIOUS INJURY OR DEATH.</p> <ol style="list-style-type: none"> 1. Read and follow all instructions in this manual, including all safety warnings to protect yourself and others from serious injury, explosion, or electrical shock. 2. Comply with all applicable codes including: the National Electrical Code; federal, state, and local codes; and other applicable safety codes. 3. To protect yourself and others from being struck by vehicles, block off your work area during installation or service. 4. Do not alter or modify any component or substitute components in this kit. 5. Warning! Substitution of components may impair intrinsic safety. 6. Field wiring to the Probe must be at least 50mm from any non-intrinsically safe device's wiring. 7. Warning! To prevent ignition of flammable or combustible atmospheres, disconnect battery before servicing. 8. Before installing or taking the unit into a hazardous area, earth the unit in a safe area to remove any static charge. Then immediately transport the unit to the installation site. Do not rub or clean the unit prior to installation. Cleaning is not required under normal service conditions. Do not rub or clean the unit after installation. If the unit is not fixed to a known earth point when installed, ensure that a separate earth connection is made to prevent the potential of a static discharge. When fitting or removing the unit, use of anti-static footwear or clothing is required.

NOTE Failure to install this product in accordance with its instructions and warnings will result in voiding of all warranties with this product.

Safety Symbols

The following safety symbols may be used throughout this manual to alert you to important safety hazards and precautions.

 <p>EXPLOSIVE Fuels and their vapors are extremely explosive if ignited.</p>	 <p>FLAMMABLE Fuels and their vapors are extremely flammable.</p>
 <p>SLIPPERY Curved metal tank surfaces can be extremely slippery. Wear approved boots with slip resistant soles.</p>	 <p>FALLING OBJECTS Being struck by even small objects falling from tall structures can result in severe injury or death. Wear your hard hat at all times when working alongside tall structures.</p>
 <p>POWER To prevent ignition of flammable or combustible atmospheres, disconnect battery before servicing.</p>	 <p>WARNING Heed the adjacent instructions to avoid damage to equipment, property, environment or personal injury.</p>
 <p>SAFETY HARNESS Injury or death resulting from falls while working on tall structures can be prevented by wearing a 5-point harness that is tethered securely by a shock absorbing lanyard to the structure.</p>	 <p>SAFETY BARRICADES Unauthorized people or vehicles in the work area are dangerous. Always use safety cones or barricades, safety tape, and your vehicle to block the work area.</p>
 <p>READ ALL RELATED MANUALS Knowledge of all related procedures before you begin work is important. Read and understand all manuals thoroughly. If you do not understand a procedure, ask someone who does.</p>	

GENERAL PRECAUTIONS

Heed service markings: Opening or removing the console cover may expose you to electric shock. Servicing of Veeder-Root equipment must be done by Veeder-Root authorized service contractors.

Use product with approved equipment: This product should be used only with Veeder-Root components identified as suitable for use with the Mag-FLEX Probe.

Use the correct external power sources: This product should be operated only from the type of power sources indicated on the electrical ratings labels affixed to the components. If you are not sure of the type of power source required, consult your Veeder-Root authorized service contractor.

Mag-FLEX Probe cable length: The length of the cable from its exit point in the tank riser or tank fitting to the transmitter cannot exceed 10 feet.

Wet or below grade installations: Installation of this equipment in wet or below grade locations requires that the installer take steps to ensure that the equipment is mounted above the maximum water level.

The Mag-FLEX Probe insertion length is critical to ordering and installing the correct probe into the correct tank. An improper probe length could result in the probe weight coming in contact with the tank bottom resulting in inaccurate fuel height measurement and possible probe damage.



CAUTION! THE TRANSMITTER WILL NOT FUNCTION PROPERLY IN WATER. ALSO, SUBMERSION OF THE TRANSMITTER IN WATER CAN CAUSE PERMANENT DAMAGE TO THE INTERNAL ELECTRONICS.

SPECIAL TOOLS REQUIRED FOR TRANSMITTER INSTALLATION

- Wrenches to tighten clamp bolts
- Small blade screwdriver (max. blade width 3/32")
- Wire strippers
- T-10/T-15 Torx drivers
- Tape measure
- Thread sealant or PTFE tape

General AST Guidelines

Above ground storage tanks (AST's) are an essential element in the distribution of petroleum products. Refer to the following organizations for applicable standards associated with AST's:

- American Petroleum Institute (API) – www.api.org
- National Fire Protection Association (NFPA) – www.nfpa.org
- Occupational Safety and Health Administration (OSHA) - www.osha.gov
- Petroleum Equipment Institute (PEI) – www.pei.org
- Steel Tank Institute (STI) – www.steeltank.com
- Underwriters Laboratories (UL) – www.ul.com

The above organizations may not address requirements imposed by individual jurisdictions. Each site owner must ensure that contractors performing the work be knowledgeable of all applicable regulations. It is fully the responsibility of the contractor, or employee performing the work, to abide by any and all additional Federal, State, or local laws, regulations and manufacturer's requirements that apply to the specific work being done. It is also the responsibility of each contractor to ensure that subcontractors abide by all applicable safety requirements. Construction related activities are covered by OSHA regulation 29 CFR 1926.

AST tanks must be properly grounded according to local codes and regulations.

AST Construction Safe Work Practices

Department of Labor rules for construction work practices are governed by OSHA as described in the Code of Federal Regulations (CFR):

Title 29, Volume 8, Part 1926 - Safety and Health Regulations for Construction. Copies of these regulations are available from OSHA's web site located at 29 CFR 1926 (<http://www.osha.gov>). Most maintenance and other operations are covered by OSHA 29 CFR 1910 (General Industry) regulations. These documents highlight many of the Federal OSHA requirements that may apply to maintenance and construction work in the retail petroleum/convenience business, but there is much more in the regulations than can be covered here. Some relevant subsections are listed:

1910.66: Appendix C - Powered platforms, Man lifts, and Vehicle-Mounted Work Platforms

1910.23: Walking - Working surfaces - Guarding

1910.132: Personal Protective Equipment

Additional important information is available in the API publication: **Safe Work Practices for Contractors Working at Retail Petroleum/Convenience Facilities**, API Recommended Practice 1646 First Edition, August 2006, Product No. A16461. For more Information about API Publications, Programs and Services, go to www.api.org. The requirements and recommended practices contained in this document are the minimum safety procedures with which everyone shall comply while working at a retail petroleum/convenience facility.

In addition, a task specific Job Safety Analysis shall be completed before any work may begin.

Personal Protective Equipment

The list below contains recommended clothing and protective equipment. Additional items may be advisable depending on the job's particular circumstances:

- 5-point safety harness
- 6-foot maximum, shock absorbing lanyard (there must be a support structure on top of the tank to which the safety lanyard/harness can be attached)
- Hard hat
- Safety glasses
- Safety footwear (ANSI Z41)
- Long pants
- Gloves - leather for materials handling, cut-resistant for sharp materials
- A heavy canvas bag with handles to hold tools and pre-assembled parts

Before you Begin

The instructions in this manual assume:

- The top of the tank has a 1-1/2" or larger bung to receive the 1-1/2" process connection.



IMPORTANT! The opening selected for the Mag-FLEX Probe must be as far as possible from the tank inlet piping.

WIRELESS INSTALLATIONS

- The TLS RF console and receiver are installed.
- The TLS console is installed. Note: the Mag-FLEX Probe is only compatible with TLS Consoles installed with Wireless 2 (2-Way) components supplied by V-R. The Mag-FLEX Probe is for inventory only applications. Leak detection is not available.
- Do not mix Wireless 1 and Wireless 2 components on the same site or system. In each Wireless 2 System, there is only one Receiver and one optional Repeater.
- The combination of the Mag-FLEX Probe, TLS RF Transmitter and Battery Pack form an intrinsically safe system and as such must be installed according to the instructions listed in this manual.
- Consult the TLS RF system manual 577013-964 for wireless component setup and operation.

HARD-WIRED INSTALLATIONS

- The TLS console is installed.
- Wiring from probe to ATG complies with requirements outlined in the respective console's site prep manual.

Mag-FLEX Probe Overview

Product Description

The Mag-FLEX is digital flexible probe is able to read temperature, product level and water level in the tank.

The Mag-FLEX Probe is a corrugated flexible probe designed to be used with any TLS console wherever there is a requirement to monitor liquid levels higher than the current maximum height of Veeder-Root Mag probes (3.66m). The following table details Mag-FLEX maximum measuring heights:

Any combination of Mag probe and Mag-FLEX can be connected to a TLS console, up to the maximum number of inputs available on the channel.

The Mag-FLEX Probe has a weight and magnet at the base of the probe to give stability, suitable for use in a wide range of products and available with or without water detection. The Mag-FLEX Probe with standard water float uses a process connection requiring a 1-1/2" tank entry point with a BSP thread or 2" NPT when using the included adapter. Table 1 lists minimum tank opening required for the Veeder-Root Mag-FLEX probe with the standard water float and with the optional low level water float.

Table 1. Dimensions For Mag-FLEX Probe Tank Opening

V-R Water Float	V-R Water Float OD inch (mm)	Recommended Tank Opening Size	
		inch	mm
Standard	1.7 (43)	2	50
Low Level	3.8 (96.52)	4	100

Mag-FLEX Probe Limitations

Maximum Limits	Console Series				
	TLS-450/TLS-XB	TLS4/8601	TLS-350	TLS-300	TLS2
Probe Length in Feet	54.5	54.5	54.5	54.5	32
Probe Length in Inches	654	654	654	654	384
Probe Length in Centimeters	1,661	1,661	1,661	1,661	975
Tank Volume in Gallons	2,641,720	2,641,720	999,999	999,999	260,000
Tank Volume in Litres	9,999,999	9,999,999	3,785,408	3,785,408	984,207
Maximum Number of Mag-FLEX Probes per Console	32	12	16	2 or 4	6
Console Software Oldest Compatible Version	1C	1	22	22	1

Mag-FLEX Technical Data

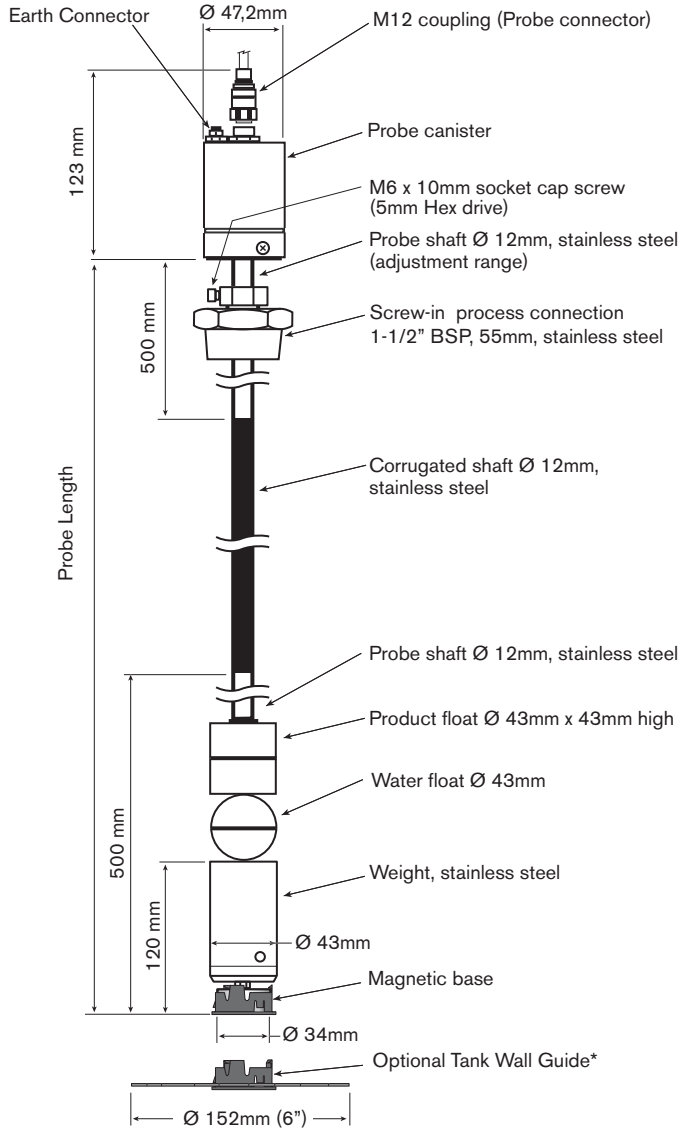

*Part of Low Level Water Float Kit.

- **Level accuracy:**
 - Precision: +/- 2mm
 - Repeatability: +/- 0.5mm
 - Resolution: 0.001 mm
- **Digital communication**
- **Temperature sensing**
- **Water detection (optional)**
- **Max liquid height: 15.0m**
- **Top mounted**
- **Process connection: for height adjustable installation R 1½", stainless steel**
- **Optional 1-1/2" BSP - 2" NPT adapter included**
- **Electrical connection: M12 connector**
- **Housing index of protection: IP68**
- **Sensor materials:**
 - Housing in stainless steel: 303
 - Tube: 316Ti
 - Corrugated hose: 316L
- **Weight: stainless steel: 316L; encapsulation of retaining magnet: conductive plastic (PTFE with graphite)**
- **Operating temperature range: -40°C to +60°C**

Mag-FLEX Probes Part Number Specification

Important: the instructions below are intended as reference material only, the Gilbarco Veeder-Root training modules contain comprehensive information and must be completed before any installation work is attempted - contact Gilbarco Veeder-Root for details.

Table 2. Part Number Nomenclature

P/No.	Petrol/E10	Diesel	No WD	Probe Minimum Length (ft)	Probe Maximum Length (ft)	Approvals
889590	-103	-203	-303	13.16	16.40	UL/cUL
	-104	-204	-304	16.44	19.69	
	-105	-205	-305	19.72	22.97	
	-106	-206	-306	23.00	26.25	
	-107	-207	-307	26.28	29.53	
	-108	-208	-308	29.56	32.81	
	-109	-209	-309	32.84	36.09	
	-110	-210	-310	36.12	39.37	
	-111	-211	-311	39.40	42.65	
	-112	-212	-312	42.68	45.93	
	-113	-213	-313	45.96	49.21	

MAG-FLEX SPARE PARTS AND ACCESSORIES

<u>Item</u>	<u>Part Number</u>
Leader Cable with M12 Connector	908704 (Spare part only, supplied with all new probes)
Optional 1-1/2" BSP to 2" NPT adapter	579008-708
Optional 2" NPTF to 4" NPTF adapter	333535-001
Optional Low Level Water Float Kit	330020-776 (Gasoline); 330020-777 (Diesel)

National Electrical Code Compliance

The following information is for general reference and is not intended to replace recommended National Electric Code (NEC) procedures. It is important for the installer to understand that electrical equipment and wiring located in Class I, Division 1 and 2 installations shall comply with the latest appropriate articles found in the National Electric Code (NFPA 70) and the Code for Motor Fuel Dispensing Facilities and Repair Garages (NFPA 30A), or other local codes such as the CEC, Canadian Electrical Code.

AST tanks must be properly grounded according to NFPA 70 and applicable local codes and regulations.

MAG-FLEX PROBE WIRE LENGTH

Improper system operation could result in undetected potential environmental and health hazards if the Mag-FLEX Probe to TLS RF Transmitter wire runs exceed 10 feet.

Veeder-Root Parts

- Veeder-Root Mag-FLEX Probe, P/N 889590-XXX
- Optional Veeder-Root Mag-FLEX Wireless Installation Kit (includes mounting hardware, transmitter and battery pack), P/N 330020-770
- Single-Channel Encapsulation Kit, P/N 848100-001
- Dual-Channel Encapsulation Kit, P/N 848100-002

Example Drawings

Example Mag-FLEX Probe Site Layout Drawing - Wireless Installation

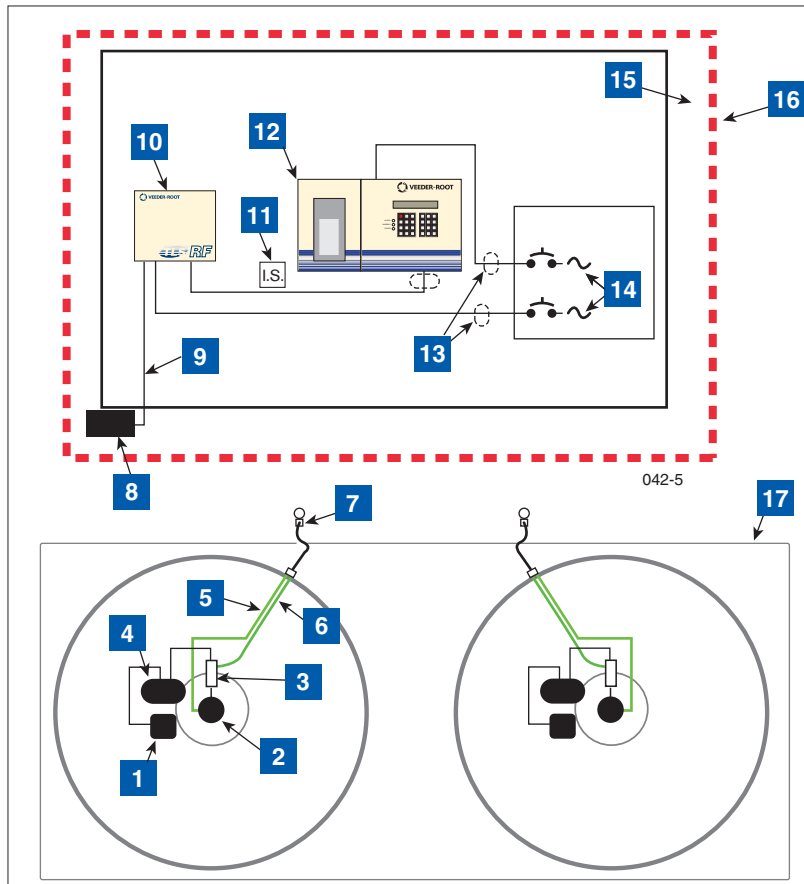

Figure 1. Site Drawing - Example TLS RF Wireless 2 System Site Layout – Two Mag-FLEX Probes

LEGEND FOR NUMBERED BOXES IN Figure 1

To be installed in accordance with the National Electrical Code, NFPA 70 and the Code for Motor Fuel Dispensing Facilities and Repair Garages (NFPA 30A), or other local codes.

1. Battery Pack
2. Mag-FLEX probe
3. Junction box
4. Transmitter
5. 4mm² diameter (10 gauge) ground wire from probe canister to tank ground.
6. 4mm² diameter (10 gauge) ground wire from junction box to tank ground.
7. AST grounding cables and earth electrodes according to NFPA70, NFPA30A and local codes (ref. example in Figure 3).
8. Receiver
9. RS-485 cable (Belden#3107A or equiv.)
10. TLS RF (Vm=250V)
11. Intrinsically safe wiring
12. TLS console (Vm=250V)
13. Conduit that enters power wiring knockouts
14. 120 or 230 Vac from power panel - separate branch circuits are required for the TLS RF and TLS console.
15. Non-hazardous area
16. Hazardous area (Class I, Div. 1, Group D)
17. Concrete tank pad.

Example Mag-FLEX Probe Site Layout Drawing - Hard-Wired Installation

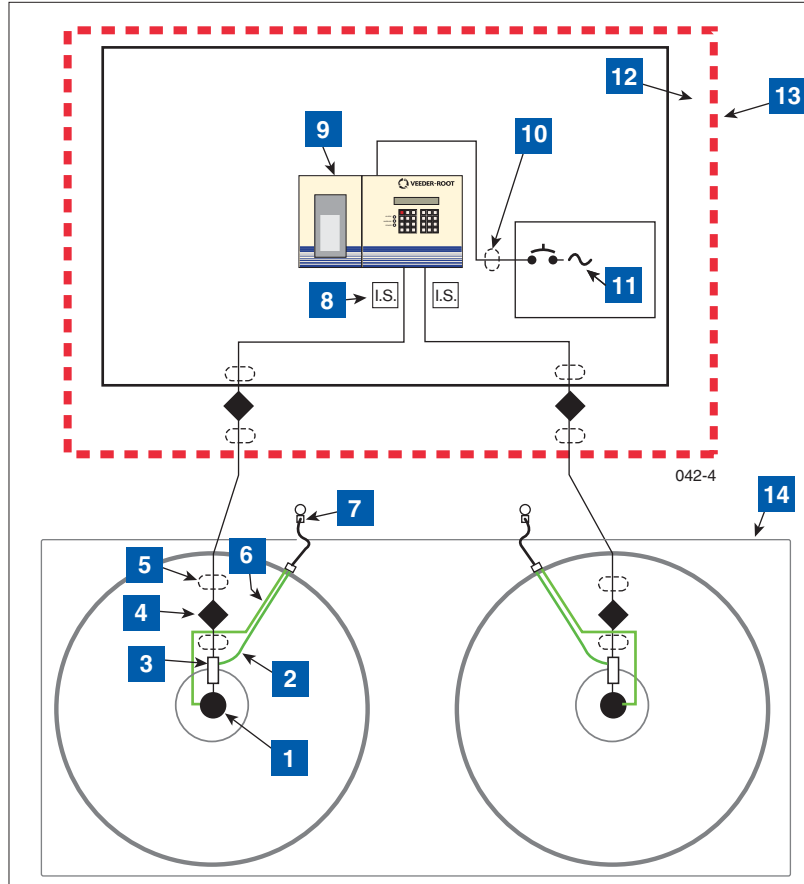

Figure 2. Site Drawing - Example Hardwired System Site Layout – Two Mag-FLEX Probes

LEGEND FOR NUMBERED BOXES IN Figure 2

To be installed in accordance with the National Electrical Code, NFPA 70 and the Code for Motor Fuel Dispensing Facilities and Repair Garages (NFPA 30A), or other local codes.

- | | |
|---|--|
| <ul style="list-style-type: none"> 1. Mag-FLEX probe 2. 4mm² diameter (10 gauge) ground wire from junction box to tank ground. 3. Junction box 4. Seal off 5. Conduit 6. 4mm² diameter (10 gauge) ground wire from probe canister to tank ground. 7. AST grounding cables and earth electrodes according to NFPA70, NFPA30A and local codes (ref. example in Figure 3) 8. Intrinsically safe wiring 9. TLS console (Vm=250V) | <ul style="list-style-type: none"> 10. 120 or 230 Vac from power panel - separate branch circuits are required for the TLS RF and TLS console. 11. Non-hazardous area 12. Hazardous area (Class I, Div. 1, Group D) 13. Concrete tank pad. |
|---|--|

Mag-FLEX Probe Length Calculation

Before ordering the Mag-FLEX Probe, an accurate dimension for "1" must be obtained. Measure internally the Insertion Length of '1' from the 1½" entry point to the bottom of the tank (see Figure 3). Probe length for ordering purposes = Length of '1' + 250 mm

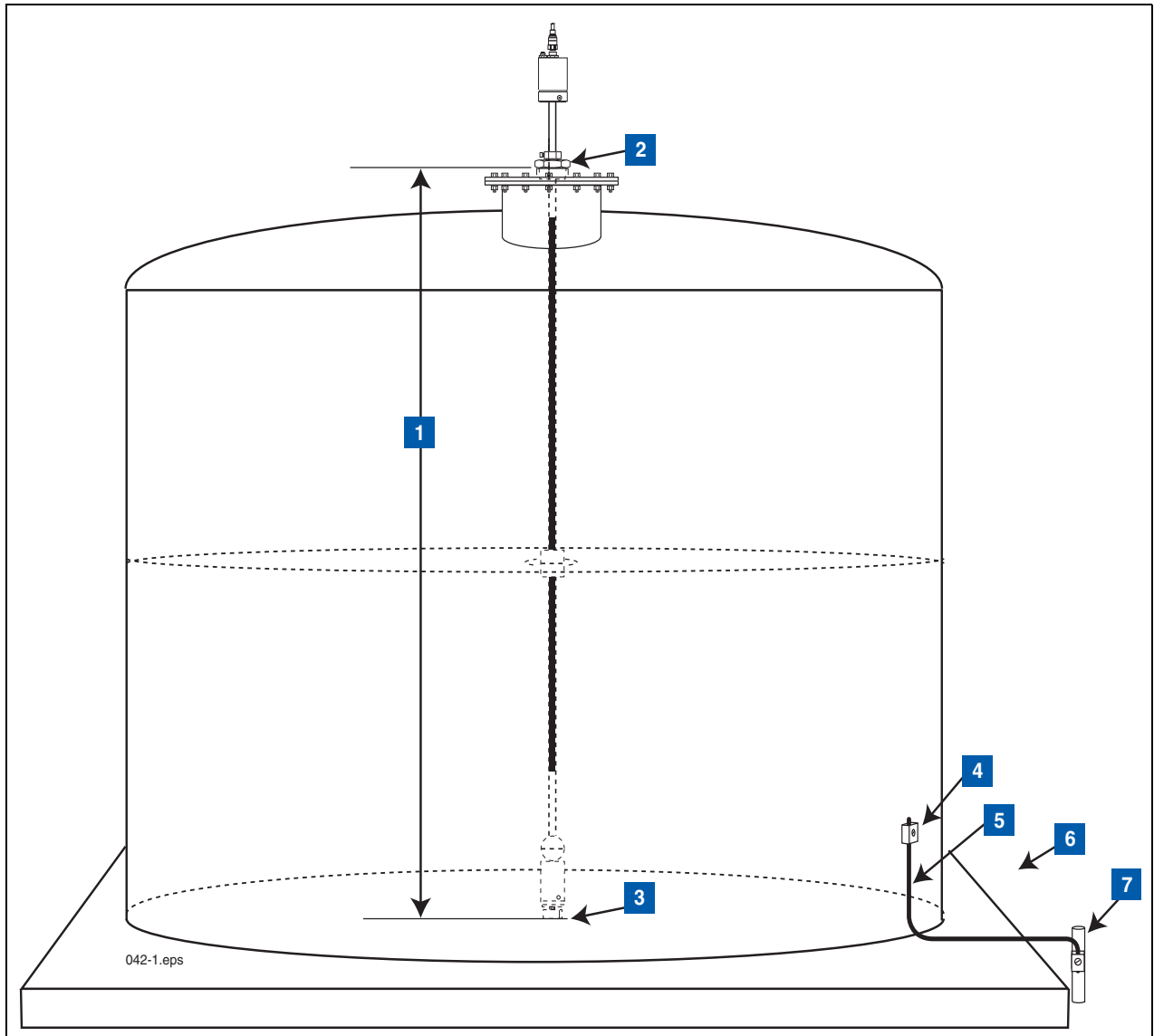

Figure 3. Mag-FLEX Probe Parameters

LEGEND FOR NUMBERED BOXES IN Figure 3

- | | |
|---|---|
| <ol style="list-style-type: none"> 1. Measured insertion Length (see Table 2 for probe form number to order - always order smaller probe if measured insertion length falls between two probes in the table). 2. Insertion measuring point for 1-1/2" BSP gland (top of entry bung). 3. Magnet rests on tank bottom. | <ol style="list-style-type: none"> 4. Tank grounding bracket 5. Grounding cable 6. Concrete tank pad 7. Earth grounded electrode with cable bracket |
|---|---|

Probe Handling

It is important to handle the Mag-FLEX probe with care at all times during the installation. Avoid excessive bending of the probe especially at the points the ridged sections meet with the flexible shaft. Below you can see examples of mishandling that would cause irreversible damage to the probe and invalidate the terms of warranty.



System Safety Layout



NOTES:

Conduit/ducting requirements are dependent on local electrical regulations.

WARNING: Substitution of components may impair intrinsic safety. Probe, probe wiring and console wiring are intrinsically safe only when connected via this barrier.

Field Cable Ducting / Cable Trays



WARNING!

Explosion could occur if other wires share ducts with intrinsically safe circuits. Ducting from probes or sensors must not contain any other wiring.

FAILURE TO COMPLY WITH THE FOLLOWING WARNINGS AND SAFETY PRECAUTIONS COULD CAUSE DAMAGE TO PROPERTY, ENVIRONMENT, RESULTING IN SERIOUS INJURY OR DEATH.

Minimum diameters for underground probe ducting are:

- Up to 20 cables -100 mm diameter
- Up to 50 cables -150 mm diameter

Run suitable diameter cable ducting and / or cable trays from the TLS Console to each Mag-FLEX probe location. For underground tanks, all cable duct entry points must be sealed to prevent the escape of hydrocarbon vapour and liquid and the ingress of water. Cable duct & cable tray plans must be designed to suit local site requirements and must conform to local/national regulations and industry standards.

For multiple TLS installations, the Mag Probe and Mag-FLEX cabling for one TLS system must be contained in separate cable duct or tray to those cables belonging to another TLS system. Combining cables from different TLS systems will be in violation of the intrinsically safe approval for this system and is not permitted. Combining cables from different systems may also result in improper system operation.

Unless specified otherwise, any draw pits should be sited at 10 metre intervals or where acute cable duct angles are unavoidable.

Ensure that all ducting is equipped with cable pull through ropes and that all visible cable ducts are properly fixed and finished off in a neat and tidy manner.

All above ground cable runs should be properly secured and adequately protected from accidental damage.

Cable Specifications For Intrinsically Safe Apparatus Cabling

Cable must be installed to comply with local and national regulations in force at the time of installation. It is the Installer's responsibility to ensure that the installation complies with all relevant local and national legislation and codes of practice.

Do not run the Mag-FLEX probe cable from the tank to the TLS Console in the same cable duct as non-intrinsically safe wiring.

Gilbarco Veeder-Root requires the use of shielded cable for Mag-FLEX cabling. The cable must have a minimum conductor CSA of 0.75 mm² and must meet with intrinsically safe system installation requirements. The cable capacitance, inductance and L/R ratio must conform to the intrinsically safe output characteristics of the TLS Console and the intrinsically safe input characteristics of the Mag-FLEX probe.

Field Cable, ATG to Probe, direct burial cable, V-R P/N 848100-2XX.



The TLS Console to Mag-FLEX probe cable length must not exceed 300 meters.

Mag-FLEX Installation & Handling Procedures

Probe Installation Requirements

Installation requires a minimum of two people to allow correct handling of the probe. Please note that the flexible and therefore fragile nature of the Mag-FLEX probe makes it more prone to mechanical shock. The probe must not be unpacked until it has been brought to its place of installation and where possible unpacked at the Tank top. The probe corrugated shaft is supplied in a 1 meter diameter coil this coil MUST not be reduced in size. The packaged curve is the maximum bend possible to prevent damage.

Miscellaneous Requirements

TANK ENTRY

The tank entry point provided must have an internal thread of 1 1/2" BSP. Two optional adapters are available:

- Optional 1-1/2" BSP to 2" NPT adapter (P/N 579008-708)
- Optional 2" NPTF to 4" NPTF adapter (P/N 333535-001)

PROBE ASSEMBLY

The process connection, water float, product float, weight and magnet are shipped pre-assembled on the probe.

TOOLS AND MATERIALS

Before starting the installation you should have the following tools & materials:

- Mag-FLEX probe suitable for the tank height. See Mag-FLEX Probe Length Calculation on page 12.
- 2-Core probe cable run from TLS location to tank top. See Cable Specifications For I.S. Apparatus Cabling on page 14.
- Optional junction box, part number 848100-004
- Non-sparking 55mm WAF (Width across Flat) spanner to tighten the 1-1/2" BSP process connection
- Non-sparking 65mm WAF spanner to tighten 2" NPT adapter (if used)
- Liquid sealing material for process connection, compatible with the tank material & product to be monitored
- Non-sparking Hexagon key (5mm) for the locking screw
- Non-sparking 30mm Spanner for the gland 30mm WAF (Width across Flat)
- Measuring tape to establish the correct position to lock the probe shaft into place
- For wireless installs - VR Kit 330020-770
- For hardwired installs - necessary conduit and seal offs as required
- Strap wrench (5-inch pipe capacity minimum)

Mag-FLEX Probe Installation

1. Unpacking the Probe

The probe shipping box is 1.1m square and 12cm deep. The probe is coiled to a diameter of approximately 1m. The probe should not be unpacked until the tank is ready to accept it. Where possible, the probe should be transported to the top of the tank in its packaging.



2. Removal of the packaging

Two people are required to remove the probe from its packaging to prevent any kinking or distortion of the flexible probe shaft. Damage caused by mishandling will not be covered under warranty.



CAUTION!

- If there is deformation at the transition points between probe shaft and corrugated sections extreme care must be taken to straighten them before installation into the tank.
- Always keep the probe coils parallel. Do not lift one coil separately from the others. Never twist one coil 90° from the others.
- Do not twist the probe during installation. Always keep the coils of the probe parallel. "Unroll" it progressively into the tank.
- Do not let the coil become less than 1m in diameter whilst uncoiling.

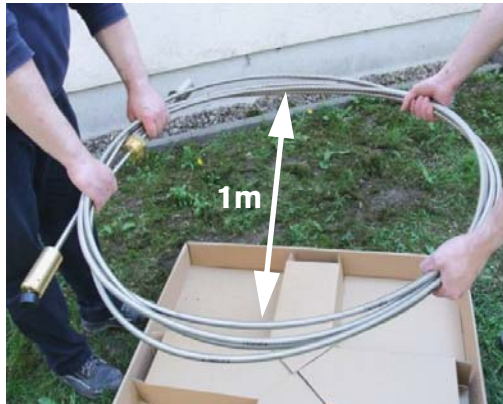

3. Probe held ready for installation

The coil should be held as shown maintaining the coiled shape to prevent kinking.

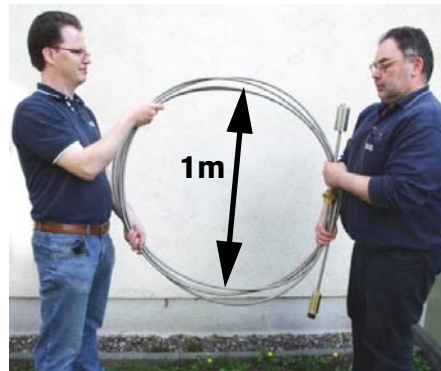

4. Process Connection

With the 5mm hex key, loosen the socket cap screw and gland. Slide the process connection towards the probe head and temporarily secure.

Standard 2" Water Float

If needed, screw the optional 1-1/2" BSP to 2" NPT adapter into the tank opening and tighten with a 65mm WAF spanner.

Optional 4" Low Level Water Float (LLWF)

If the 4" LLWF is being used, screw the optional 2" NPTF to 4" NPTF adapter into the 4" tank opening and tighten with the strap wrench.



5. Lowering the probe through the tank opening

Standard 2" Water Float

Lower the probe's magnetic base and floats into the tank opening.

Optional 4" LLWF

With the 4" LLWF removed, slip the optional 1-1/2" BSP to 2" NPT adapter over the magnetic base and existing floats. Snap the 4" LLWF onto the S.S. ball float as described in the LLWF manual (577014-056). Lower the probe's magnetic base and floats into the tank as shown. As soon as the probe's base components are lowered through the 4" NPTF adapter, screw the 1-1/2" BSP to 2" NPT adapter into the 2" NPTF to 4" NPTF adapter and tighten with a 65mm WAF spanner.



6. Feeding the probe into the tank

Unroll the corrugated shaft as the probe is lowered into the tank taking care to avoid chafing on the tank entry.



7. Corrugated shaft lowered into tank

Steel Tanks

At this point lower the probe slowly until you feel the magnetic attraction as it contacts the bottom of the tank.

Non-Steel tanks

Lower the probe until you feel the weight contact the tank bottom.



8. Installation dimension

With the probe in contact with the tank bottom and the probe held taut, measure the clearance from the lower edge of the probe canister to the top of the tank entry point (installation dimension) record this measurement.

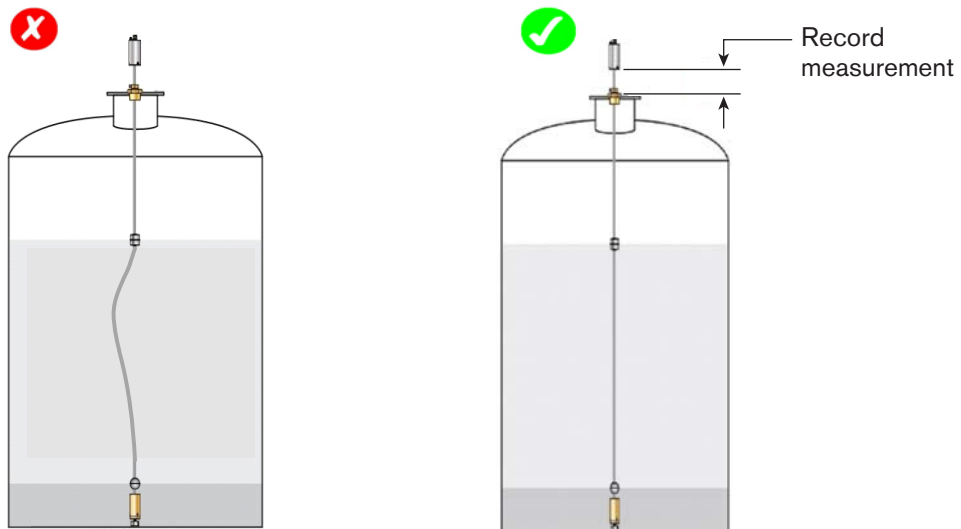

9. Fitting the process connection

Apply sealant to the thread of the process connection. Carefully lower the process connection into the tank entry fitting. Screw in and tighten using a 55mm WAF spanner.

Tighten process connection with 55mm spanner



10. Securing the probe

Raise the probe canister until the exact installation dimension that you measured & recorded in step 8 is achieved.

Attention!

Do not raise the probe any higher as it will become detached from the bottom of the tank.

With the probe in this position tighten the gland nut using a 30mm WAF spanner. Secure the locking screw with the 5mm Hexagon key.

Then secure socket cap locking screw with 5mm hex key

Earth connector

First tighten gland with 30mm spanner

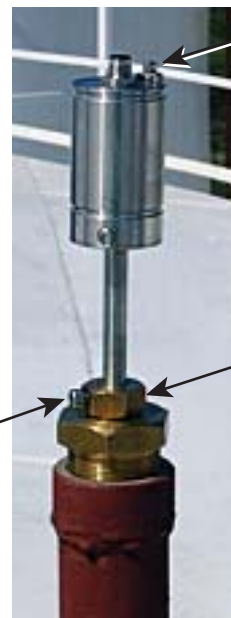

11. Example installations

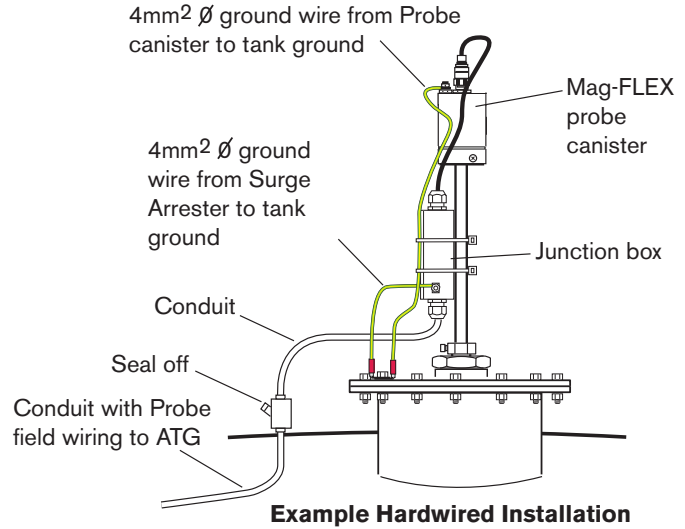
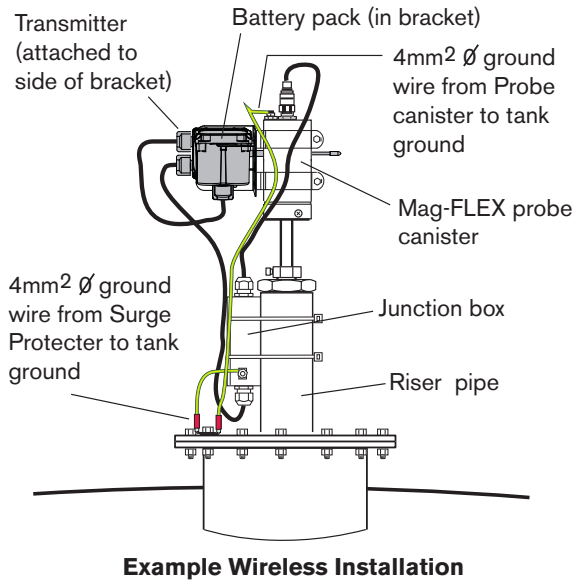

Figure 4. Junction Box Installation Examples

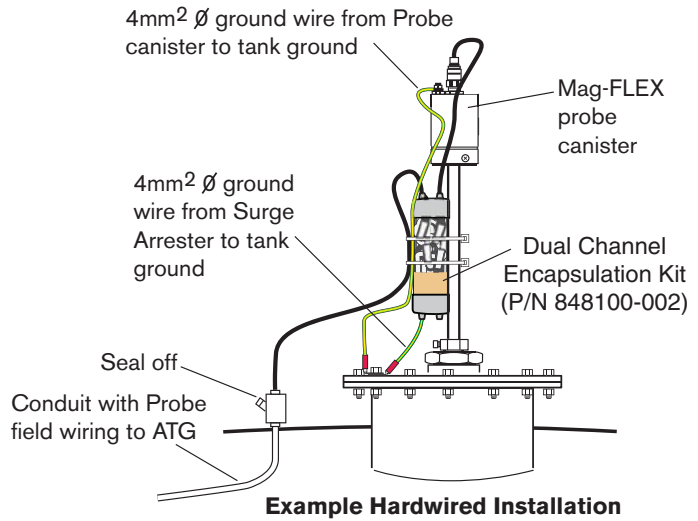
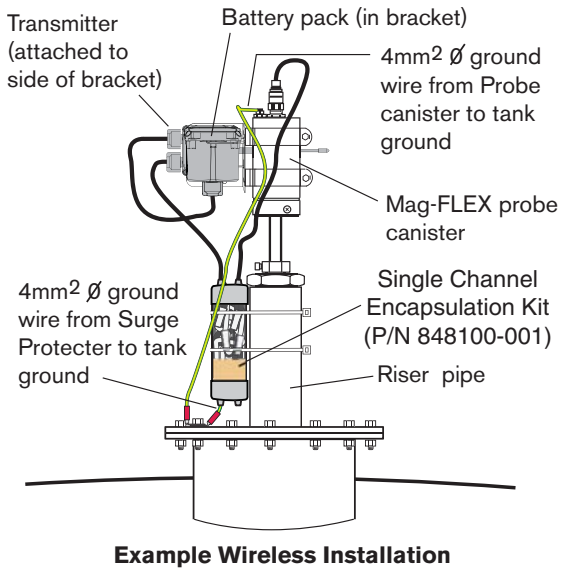
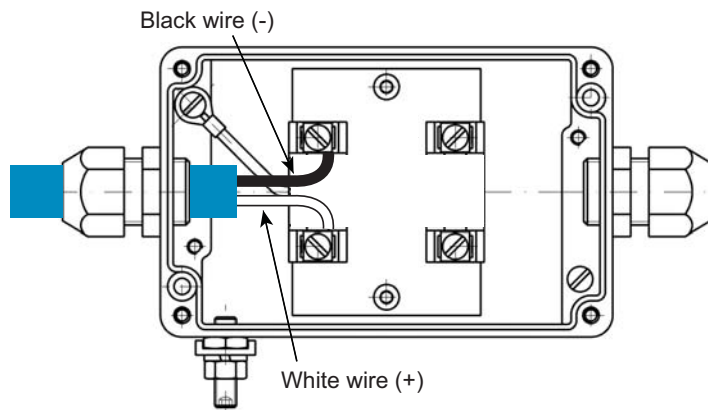

Figure 5. Veeder-Root Single- And Dual-Channel Encapsulation Kit Installation Examples

Mag-FLEX Probe Field Wiring Connections

OPTIONAL JUNCTION BOX - WIRED INSTALLATIONS ONLY

12. **Connecting the probe leader cable** - Connect the leader cable supplied with the probe to the M12 connector located on the top of the probe canister. Attach the connector of the supplied Leader Cable to the M12 connector on the probe head. First tighten the union nut of the M12 connector by hand and then tighten the nut a further 180° using an open-ended spanner. The tightening torque should be in the range of 100~150 N/cm.
13. **Fitting the screw-in gland assembly** - Connect the other end of the probe leader cable to the optional junction box as shown below.



14. Grounding the probe to the tank



A 10 gauge (4mm²) earth cable must be connected between the probe canister earth connector and tank ground.

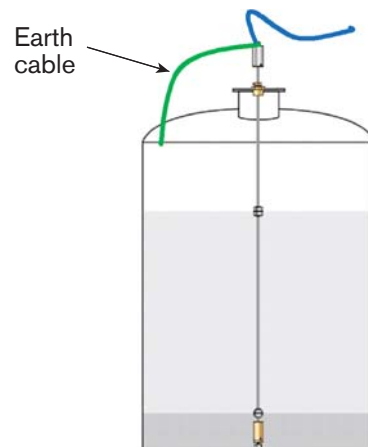

15. Grounding the optional junction box to the tank



A 10 gauge (4mm²) earth cable must be connected between the junction box and tank ground connection. The earth cable should be connected to the external saddle clamp of the junction box.

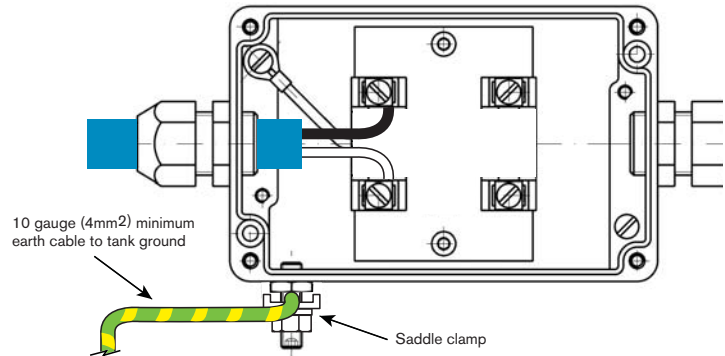

16. Field cable connection - optional junction box

HARDWIRED INSTALLS - Connect the 2 wire field cable from the TLS console to the junction box as shown. Correct polarity **MUST** be maintained. The field cable length should not exceed 300 metres.

WIRELESS INSTALLS - Connect the 2 wire field cable from the TLS RF transmitter probe to the junction box as shown.

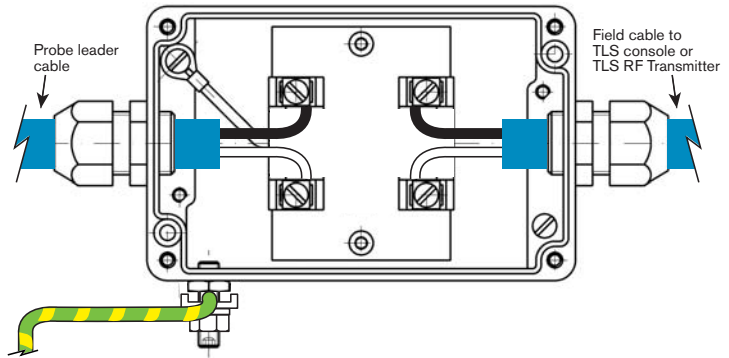

VEEDER-ROOT ENCAPSULATION KITS

1. Cut the soft vinyl epoxy enclosure end cap entrance holes of the Encapsulation Kit enclosure to accommodate each cable diameter. Keep the hole sizes to a minimum. Insert about 5 inches (127mm) of each cable through the openings [Figure 6]. Remove 3 inches (76mm) of the outer jacket from each cable. Trim the insulation from the conductors.

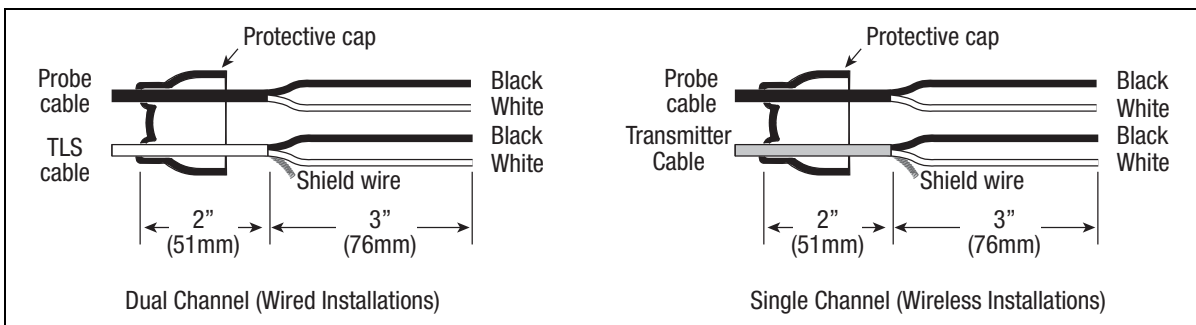

Figure 6. Splice Length Dimensions

2. Make the connections to the four black and white wires in the Encapsulation Kit using wire nuts as shown in Figure 7. Depending on the installation, cut off the TLS console or Transmitter cable's bare shield wire at the cable jacket.

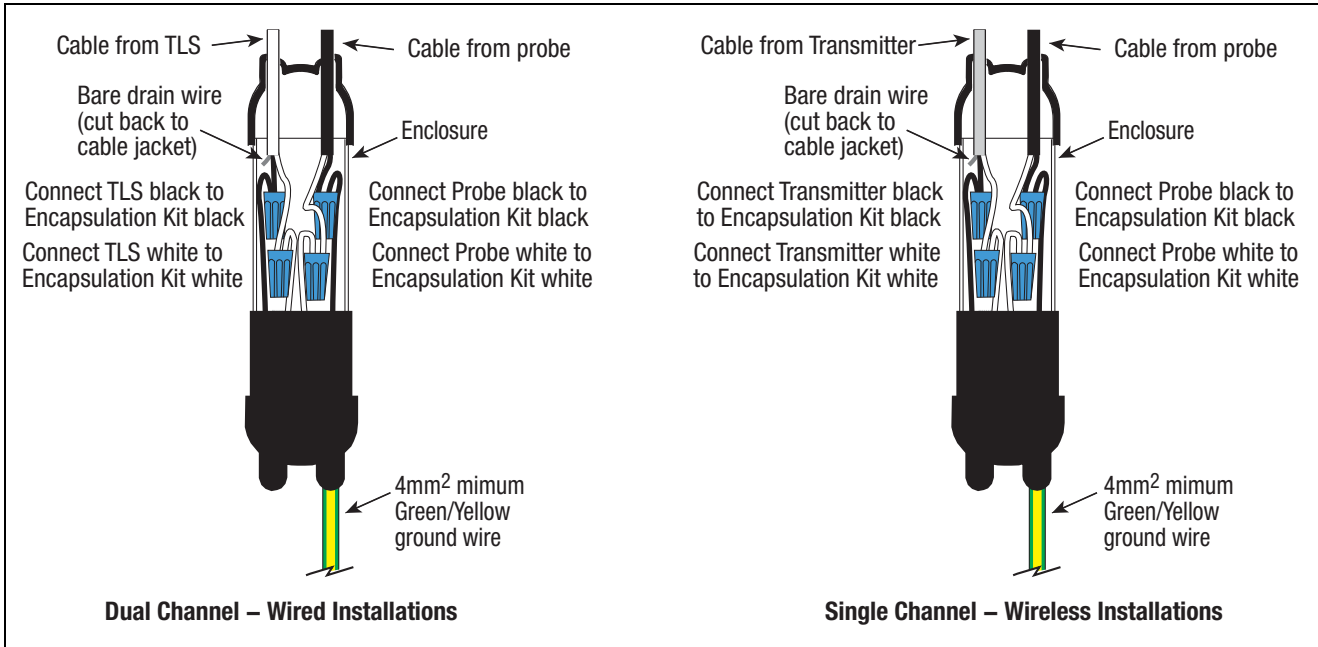

Figure 7. Splice Connections

3. Center the splices in the clear plastic sleeve. Assemble the Encapsulation Kit closure, making sure the sleeve is fully inserted into each of the vinyl end caps. Rotate the sleeve cover until both slot openings line up. Arrange the closure so the slot openings are facing up and the enclosure is as level as possible.

⚠ WARNING!	
	<p>Sealing compound contains isocyanate. Vapor and liquid may cause sensitization. May be irritating to the eyes.</p> <p>Avoid skin and eye contact. Avoid repeated and prolonged breathing of vapor. Use only in well ventilated areas. Wear chemically resistant gloves.</p> <p>Inhalation - provide fresh air. In case of eye contact flush eyes with plenty of water for 10 minutes and get medical attention. If ingested do not induce vomiting. Get medical attention. Wash with soap and water in case of skin contact.</p>

4. Remove bag of "Sealing compound" from foil package. Grasp the ends, one in each hand, then pull sharply to remove plastic clip [Figure 8].

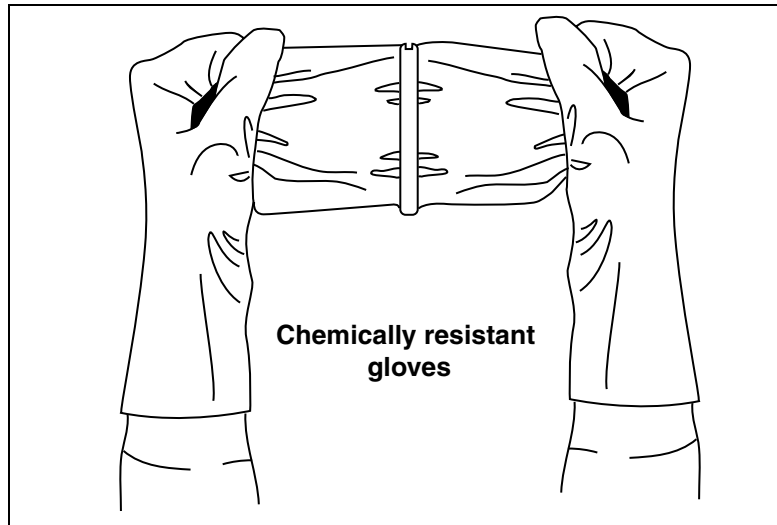

Figure 8. Removing Sealing Compound Clip

5. Thoroughly mix compound together. Invert bag several times while squeezing compound from one end to the other for a minimum of one minute.
6. Once the mixture feels warm, immediately cut one corner and slowly fill the enclosure's plastic sleeve. Stop just short of filling the entire sleeve. **Do not overfill.** [Figure 9]

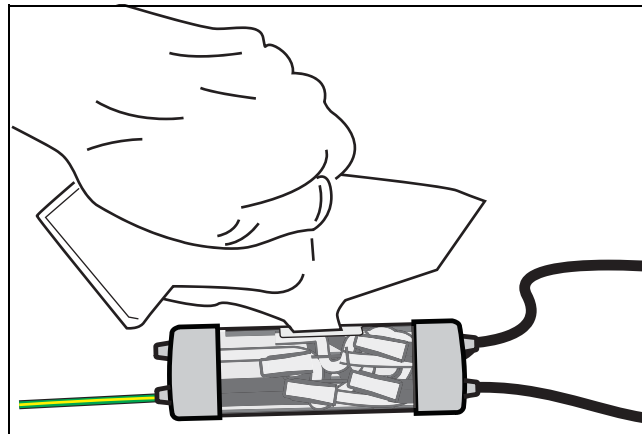

Figure 9. Pouring Sealing Compound Into Sleeve

7. With a twisting motion, rotate the outer clear plastic barrel to close the pouring slot. Wait at least five minutes, then use the large cable tie to mount the Encapsulation Kit to the riser pipe or probe canister as applicable.
8. An earth cable must be connected between the Encapsulation Kit and a tank ground connection. According to the provision of EN/IEC 60079-14, the minimum size of the earth cable shall be 4 mm². Connect the green/ yellow ground wire from the Encapsulation Kit to an appropriate tank ground (see Figure 5).



TLS setup

The TLS console Mag-FLEX setup is similar to that for a standard Mag Plus Probe setup. Listed below are the setup exceptions.

- **Float Type** - For TLS2, TLS-3XX or TLS-450 consoles, the float type must be set as 3" FLOAT (76.2 mm).
Notes:
 1. This is the default float type.
 2. Water detection starts at 5" (127 mm) therefore water height warnings and alarms should be set above 5".
 3. See manual 577014-056 for setup instructions when installing a low level water float.
- **Tank Profile** - Select 'Linear' for TLS2, TLS-3XX or TLS-450 consoles, or 'Multi-Point' if an accurate tank chart is available.
- **Tank Diameter** - For vertical cylindrical tanks, enter the full tank height here (NOT the diameter of the cylinder). Full height is the distance from the bottom of the tank to the top of the cylinder excluding the domed lid at the top of the tank. Set the height in mm.

Exit setup mode and check the inventory report, the water reading should now be "0". Check all TLS setup parameters are correct. If necessary, secure all console doors.



For technical support, sales or
other assistance, please visit:
www.veeder.com

A blue square containing a white wireframe globe icon at the top. Below the globe, the text "For technical support, sales or other assistance, please visit:" is written in white, followed by the website address "www.veeder.com" in white.